

主视图

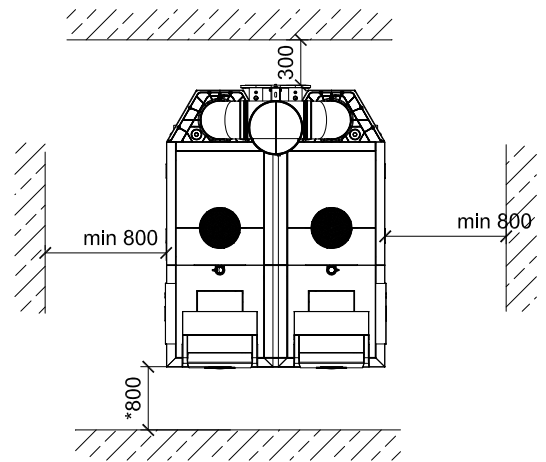

俯视图

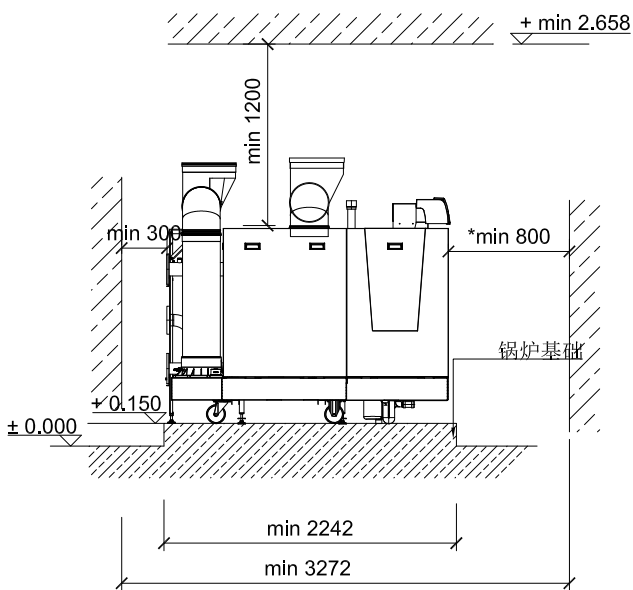

侧视图

\*注意：如果控制器安装锅炉侧面，  
前方所需空间距离为300mm。

基础和空间要求

Designed by XXX	Checked by XXX	Approved by - date XXX - 00/00/00	Filename XXX	Date 00/00/00	Scale 1:50
BDR			C630-1000ECO		
			X	Edition 0	Sheet 1/1