

主视图

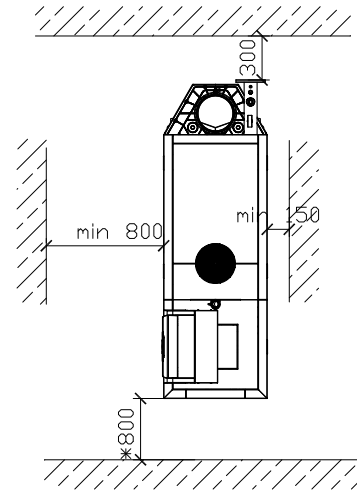

俯视图

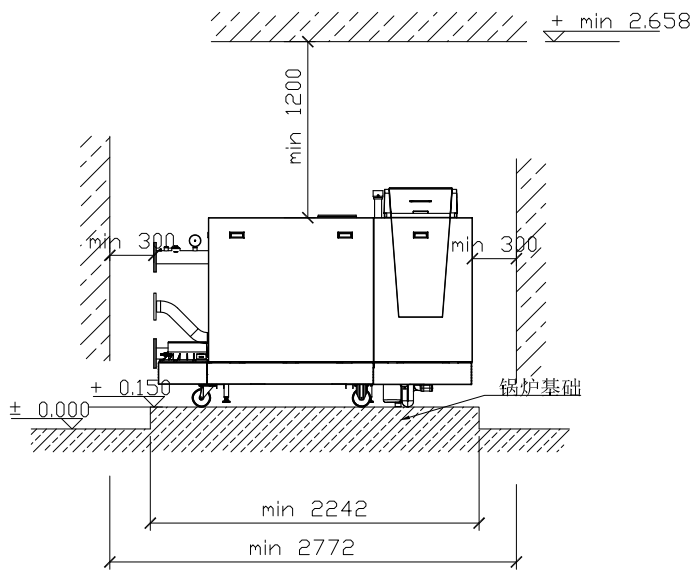

侧视图

* 注意: 如果控制柜安装在锅炉正前方,
前方所需空间距离为800mm.

基础和空间要求

Designed by XXX	Checked by XXX	Approved by - date XXX - 00/00/00	Filename XXX	Date 00/00/00	Scale 1:50
BDR			C330-650ECO		
			X	Edition 0	Sheet 1/1