

主视图

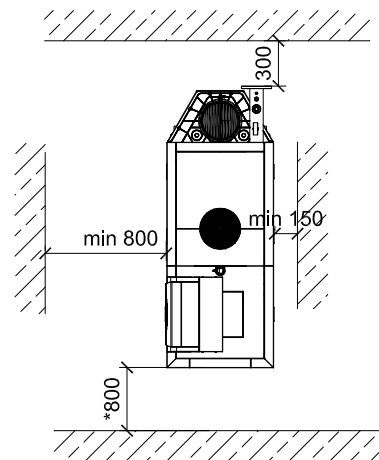

俯视图

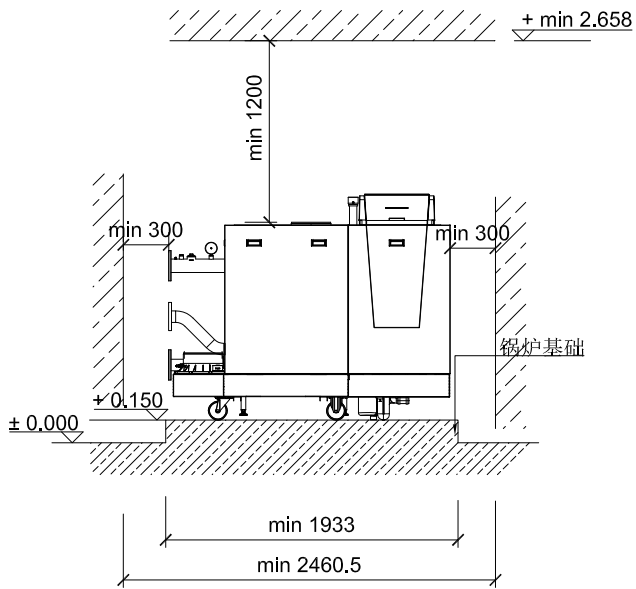

侧视图

*注意：如果控制器安装锅炉正前方，前方所需空间距离为800mm。

基础和空间要求

Designed by XXX	Checked by XXX	Approved by - date XXX - 00/00/00	Filename XXX	Date 00/00/00	Scale 1:50
BDR			C330-350ECO		
			X	Edition 0	Sheet 1/1